

WhisperTrac® 3000

The super-quiet motorized solution for draperies



WhisperTrac 3000

MechoShade Home Systems has yet again set a standard by offering an architecturally sleek and technically innovative solution for low-voltage motorized draperies.

WhisperTrac 3000 motorized system

- Operates extremely quietly.
- Can be curved up to an 8 in. (20.32cm) radius—the industry’s tightest curve.
- Offers multiple motor options, depending on the weight load. (See load tables, page 4.)
- Can be plugged into a standard wall outlet, requiring no special wiring.
- Features a clean, monochromatic, European design.
- Can be controlled by radio frequency (RF), infrared (IR), a wall switch or 3rd-party A/V, lighting, or automated control systems.
- Is suitable for residential, hotel, and corporate applications.
- Satisfies American Disabilities Act (ADA) requirements.
- Makes complex curves and multiple bends possible.

Both WhisperTrac® 24v models are powerful and technologically advanced.

WhisperTrac® 3020HD:

- Features a heavy-duty motor.
- Is the world’s quietest for its size and scale and the most powerful.
- Draws draperies to a width of over 58 ft. (17.68m).
- Holds drapery-weight loads up to 330 lbs. (149.69kg) on straight tracks. (See load tables, page 4.)
- Offers five intermediate stop positions.
- Is easily programmable by infrared (IR).
- Includes a tandem-motor option, available for extra-heavy drapery applications.

WhisperTrac® 3032MD:

- Features a medium-duty motor.
- Functions in a conversationally quiet manner.
- Can be curved up to 32 ft. (9.75m).
- Holds drapery-weight loads up to 88 lbs. (39.92kg) on straight tracks. (See load tables, page 4.)
- Is more economical than the 3020HD heavy-duty motor.

Both models:

- Operate with a decorator-style compatible paddle switch, a two- or four-button IQ® switch, a 15-channel infrared (IR) remote controller with a receiving eye, or an RF (radio-frequency) receiver and a wireless wall switch or transmitter.
- Feature symmetrical gear sets that provide universal mounts for motor placement on either end of the track.
- Can be daisy-chained with local and/or master controls.
- Interface easily with all 3rd-party A/V, lighting, and automated control systems through an internal network or a dry-contact closure.
- Available IP addressing or RS232 programming via a MechoShade Home Systems IQ/485® network-interface accessory.



**Elements of WhisperTrac
3020HD and 3032MD**

This configuration includes tandem optional accessories (indicated by numbers in black circles).

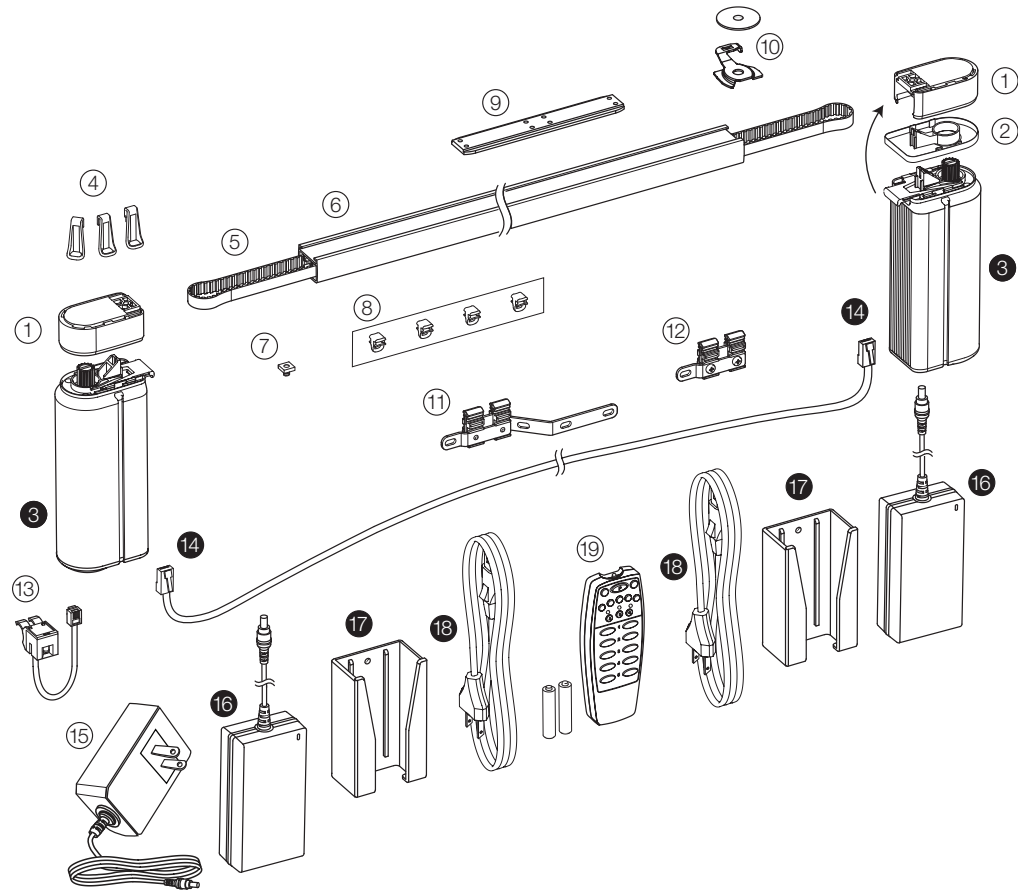

- 1. Drive-belt pulley
- 2. Drive-belt pulley cover
- 3. 3020HD and 3032MD models**
- 4. Motor-mask hooks
- 5. Drive belt, 0.39 in. (0.99cm)
- 6. Aluminum profile
- 7. End stop
- 8. Standard glider
- 9. Internal connecting bridge
- 10. Standard ceiling clamp
- 11. Overlap carrier
- 12. Underlap carrier

- 13. Infrared (IR) receiver
- 14. Motor-link cable**
- 15. 3032MD light-duty motor plug-in adapter
- 16. 3020HD heavy-duty motor transformer**
- 17. 3020HD transformer wall holster**
- 18. 3020HD 12-ft. (3.66m) power cable**
- 19. Infrared (IR) transmitter

Parts indicated by the numbers in black circles and in boldface above are needed only for a tandem installation.

- Tandem motor configuration is not available for the 3032MD model. (Use the 3020HD configuration for tandem configuration.)
- Additional shipping charges will apply to tracks that are curved in the center.
- Weight loads stated are for draperies hung completely below the track.
- If draperies are mounted to cover the track, MechoShade Home Systems cannot warranty the system and/or the performance characteristics.
- Both models can be integrated together via Infrared (IR), wall switches and/or 3rd-party control systems.

Maximum-weight load table:
3020HD heavy-duty model with standard glider WHTR 4010 10 WH
 (add 50% weight load with roller carrier)

Feet	3	7	10	13	16	20	23	26	30	33	36	39	43	46	49	52	56	58
	Maximum lbs.																	
Straight	22	44	66	88	110	132	132	132	132	132	132	132						
Straight (tandem)							154	176	198	220	220	220	176	176	176	176	176	176
1 curve	22	44	66	88	110	110	110	110	110	110	110	110						
1 curve						132	154	176	198	198	198	198	154	154	154	154	154	154
2 curves	22	44	66	88	99	99	99	99	99	99	99	99						
2 curves (tandem)					110	132	154	176	176	176	176	176	132	132	132	132	132	132
1 large curve	22	44	66	88	99	99	99	99	99	99	99	99						
1 large curve (tandem)					110	132	154	176	176	176	176	176	132	132	132	132	132	132

Maximum-weight load table:
3032MD medium-duty model with standard glider WHTR 4010 10 WH
 (add 50% weight load with roller carrier)

Feet	3	7	10	13	16	20	23	26	30	33	
	Maximum lbs.										Greater than 23 ft.: center-draw only
Straight	22	44	66	88	88	88	88	88	88	88	88
1 curve	22	44	66	66	66	66	66	66	66	66	66
2 curves	22	44	44	44	44	44	44	44	44	44	44
1 large curve	22	44	44	44	44	44	44	44	44	44	44

Legend

Tandem: Dual-motor unit.
 Curve: Tight 8 in. (20.32cm) radius bend from 10° to 90°.
 Large curve: Continuous radius bend.

The weight-load tables above for the two models indicate the maximum total-drapery weight permissible when using standard glider WHTR 4010 10 WH. This allows three gliders per foot (30.48cm), each with a maximum carrying weight of 2.2 lbs. (35.2oz) per glider.

The maximum carrying weight for the upgraded WHTR 4030 WH PL roller carrier is 3.3 lbs. (52.8oz) per carrier (table not shown).

If the total drapery weight is more than 55 lbs. (24.95kg), use heavy-duty ceiling plate WHTR 6055 10 ZP (see page 5).



WHTR 4030 WH PL
 Roller glider.



WHTR 4010 10 WH
 Standard carrier.

The drapery should not be in contact with the underside of the drapery track.

Note: If the weight load per glider is greater than the maximum weight allowed on the standard glider (2.2 lbs./35.2oz), please upgrade to the stronger WHTR 4030 WH PL roller carrier.

Components of WhisperTrac 3020HD and 3032MD

Drapery track

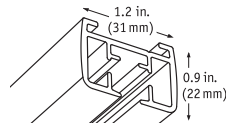

WHTR TRAK AL WH
Aluminum profile
23 ft. (7m).
Color: white.

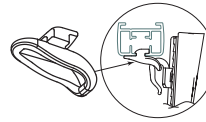

WHTR 6010 00 WH
Glider projection for
the WHTR 2024 95 HK
hook. 100 pieces
per pack.
Color: white.

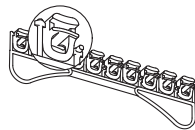

WHTR 4010 10 WH
Standard glider
(10 on a strip).
Color: white
(minimum 10 pieces).

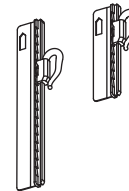

WHTR 2024 55 HK
Sew-in hook, 2.165 in.
(5.5cm). 10 pieces
per pack.
Color: white.



WHTR 4030 WH PL
Roller carrier
(special order only).
100 pieces per pack.
Color: white.

WHTR 2024 95 HK
Sew-in hook, 3.75 in.
(9.53cm) 10 pieces
per pack.
Color: white.

Ceiling mounts



WHTR 6050 49 ZP
Standard ceiling
clamp, including a
washer. Total drapery
weights of less than
55 lbs. (24.95kg).



WHTR 6055 10 ZP
Heavy-duty ceiling
plate. Total drapery
weights of less than
220 lbs. (99.8kg).
Recommended for
extra-heavy or curved
applications.
Color: white.



WHTR 6055 20 35
Mounting plate
for a recess track.
Color: white.

Accessories

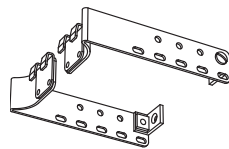

WHTR 6059 RS WH
Wall-return set (left and
right) 6 in. (15.24cm),
for wall and ceiling
mounting; can be
trimmed (minimum
3.5 in./8.89cm).
Color: white.

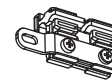

WHTR 6275 20 AD
Overlap carrier used
with WHTR 6274 20 LG.

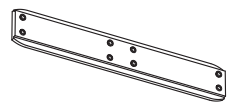

WHTR 6052 00 WH
Internal connecting
bridge standard for
tandem configurations.

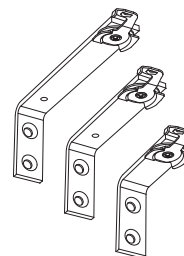

WHTR 2015 10 WH
Wall bracket, 4 in.
(10.16cm).

WHTR 2015 07 WH
Wall bracket, 3 in.
(7.62cm).

WHTR 2015 05 WH
Wall bracket, 2 in.
(5.08cm).

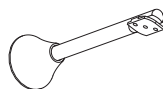

WHTR 6057 EX WH
Extension wall
bracket. Projects
from 2.75 to 6 in.
(7 to 15.24cm).



WHTR 6051 WS WH
Wall support bracket
1.575 in. (4cm).

Note: Price does not
include the ceiling fixing
clamps (shown), as
they are included in the
standard package.

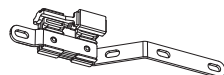

WHTR 6274 20 LG
Overlap carrier.



WHTR 1000 BD PS
Drive-belt pulley.

Components of WhisperTrac 3020HD and 3032MD

Drapery-track mounting examples

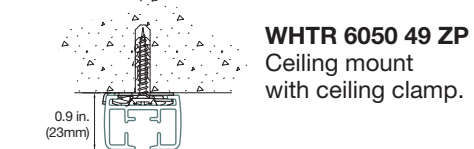

WHTR 6050 49 ZP
Ceiling mount with ceiling clamp.

Shown with the optional sew-in adjustable hook

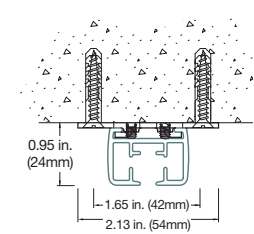

WHTR 6055 10 ZP
Ceiling mount with ceiling plate.

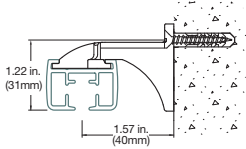
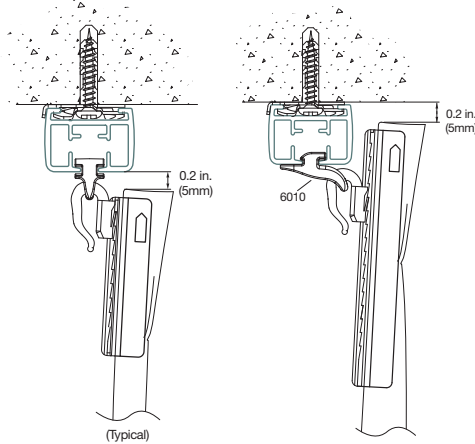

WHTR 6051 WS WH
Wall mount with wall-support bracket.

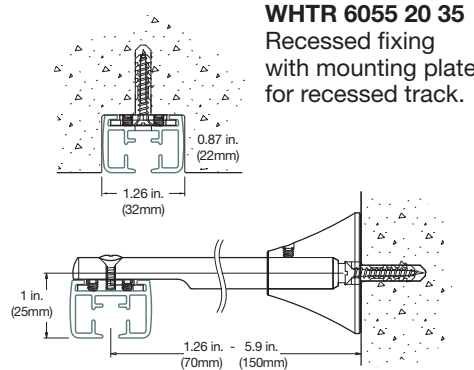

WHTR 6055 20 35
Recessed fixing with mounting plate for recessed track.

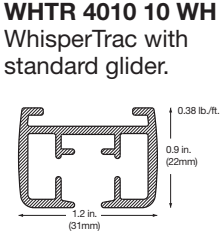

WHTR 4010 10 WH
WhisperTrac with standard glider.

WHTR 6010 00 WH
WhisperTrac with glider projection. Maximum drapery weight load is 33 lbs. (15kg). (Straight track only, less than 8 ft./2.44m).

If draperies are mounted to cover the track, MechoShade Home Systems cannot warranty systems and/or performance characteristics.

WHTR 6057 EX WH
Wall mounted with adaptable extension bracket.

WhisperTrac 3000 motors

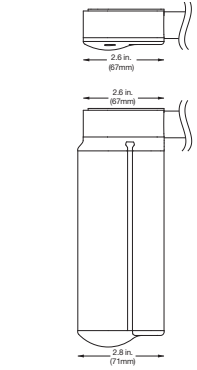

3020HD model side dimensions

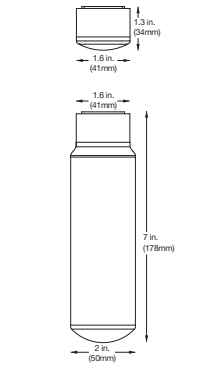

3020HD model front dimensions

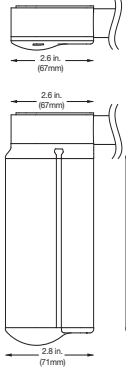

3032MD model side dimensions

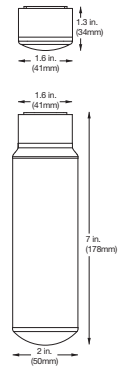

3032MD model front dimensions

Components of WhisperTrac 3020HD and 3032MD

Guidelines for Installation

- An extra bracket should be installed at the drapery stacking positions.
- Maximum total drapery weight with ceiling clamps WHTR 6050 49 ZP is 55 lbs. (25kg). For ceiling mounts with special curves and heavy draperies up to 220 lbs. (99.8kg), use heavy-duty ceiling plates WHTR 6055 10 ZP. Mount the brackets 24 to 31 in. (61 to 78.74cm) apart.
- Wall mount the track with wall support brackets WHTR 6051 WS WH that project 1.6 in. (4.1cm).
- Wall mount the track with adjustable extension wall brackets WHTR 6057 EX WH that project 2.8 to 6 in. (7.1 to 15.24cm).
- Weight per bracket should not exceed 22 lbs. (10kg), depending on the mounting surface.

Warranty

- Five-year limited warranty on all items is subject to the maximum number of operations and general terms and conditions of sales as stated in the full complete MechoShade Systems, Inc. warranty statement.
- MechoShade Systems, Inc., will not warranty systems that are installed without its own approved mounting hardware.
- The warranty is supported only when using WhisperTrac 3000 original hardware.

Electronic accessories and switches

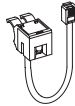

WHTR 6040 21 01
Infrared (IR) receiver.
At least one receiver is required in order to install the WhisperTrac.

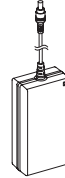

WHTR 1100 TR 24
Single 24V 3020HD heavy-duty transformer.



WHTR 6040 11 15
Infrared (IR) transmitter.
At least one transmitter is required in order to install the WhisperTrac.

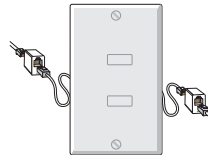

ESWX IQ02 WH WH
Two-button switch with adaptor cable and coupler connector.

Note: An installer must have one IR receiver and one IR transmitter in order to set the limits on the system.

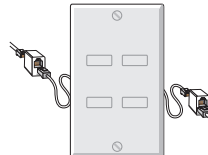

ESWX IQ04 WH WH
Four-button switch with adaptor cable and coupler connector.

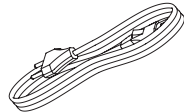

WHTR 1200 PO LE
3020HD heavy-duty power lead 12 ft. (3.66m).



ESWX 0728 ST WH
Decorator paddle switch (DPDT).



WHTR 1001 TE CA
Limit-setting switch.



WHTR 1151 WA HO
3020HD heavy-duty transformer wall holster.



WHTR 1101 TR 24
Single 24V light duty plug-in adapter.



INTE 0454 DR CO
Receiver RTS dry-contact interface.

