

TaHomA®

For Audio

Dial 866-347-6865



Presenter: Gina Lutkus
Gina.Lutkus@somfy.com

Introduction

- **What is TaHomA®**
- **Business Opportunity**
- **What is Z-Wave**
- **How to Control Somfy Motorized Product?**
- **Partners**
 - Leviton, Evolve, Cooper
- **Scenarios**
- **Introduction to programming**
- **Somfy's Marketing**

TaHomA® by Somfy: Total Home Automation

HOME MOTION by **somfy**

my TaHomA

MY SCENES



Energy Save
Away



Energy Save
At Home



Normal At
Home



Open Office



MY ROOMS



Office



Desk lamp
56



Thermostat
76 | 77



Blind

BLIND

TILT

OPEN

CLOSE

my

APPLY TO ALL

STOP

[LiveView Dashboard](#)

[Schedule Configurator](#)

[Scene Configurator](#)

TaHoma® General Description

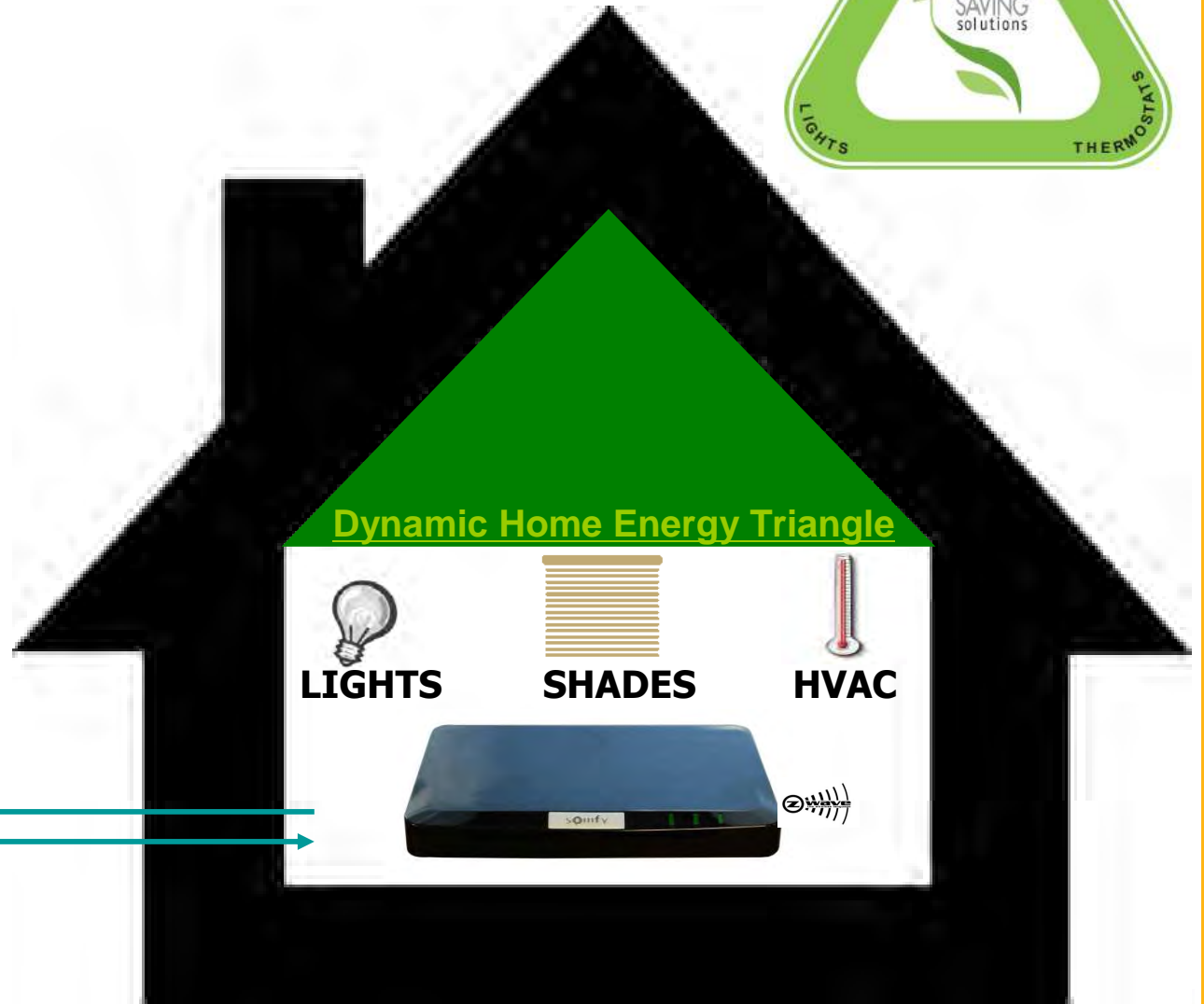

How Do I control TaHomA



iPhone



iPad



PC/Laptop

An interface to control TaHomA, could be a laptop, desktop PC, iPad or iPhone connected to the internet. This means that accessing motorized shades, lights and thermostats can be done from anywhere, whether the user is at home, at work, or on vacation

Business Opportunity

- **Sell more motorized shades, blinds, awnings, shutters...**
- **Increase Sales and Profit Margin**
- **Natural Business Expansion**
- **Scalable Solutions-Repeat Business**
- **Energy Saving Triangle**
 - Management of Natural, Artificial, and HVAC in the home

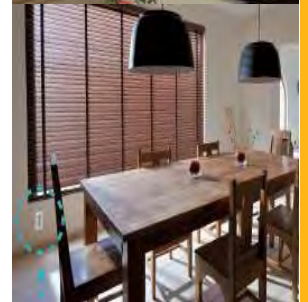
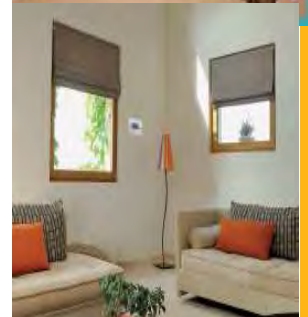

HOME MOTION by
somfy®

TaHomA Controller and Wireless Router

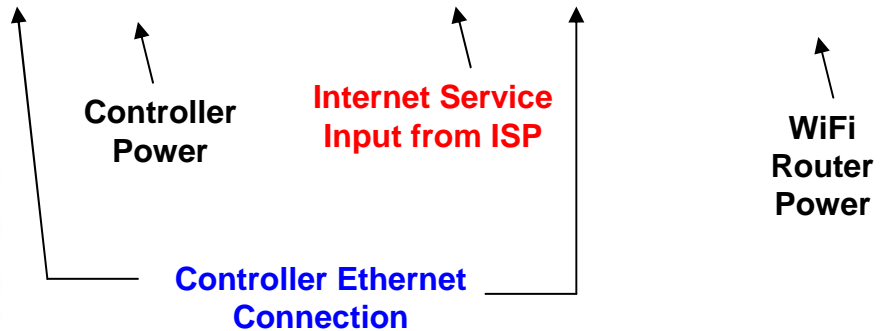

Z-Wave

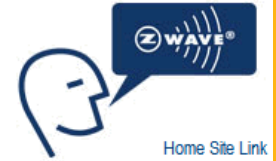

- Z-Wave is a mesh radio technology where each node or device on the network is capable of sending and receiving control commands through walls or floors and uses intermediate nodes to route around household obstacles.
- Z-Wave devices can work individually or in groups and can be programmed into scenes or events that trigger multiple devices
- Z-Wave alliance has over 160 manufacturers

Z-Wave to RTS interface *ZRTSI*

- 16 channel Z-Wave to RTS interface
- Recommended one per room/zone

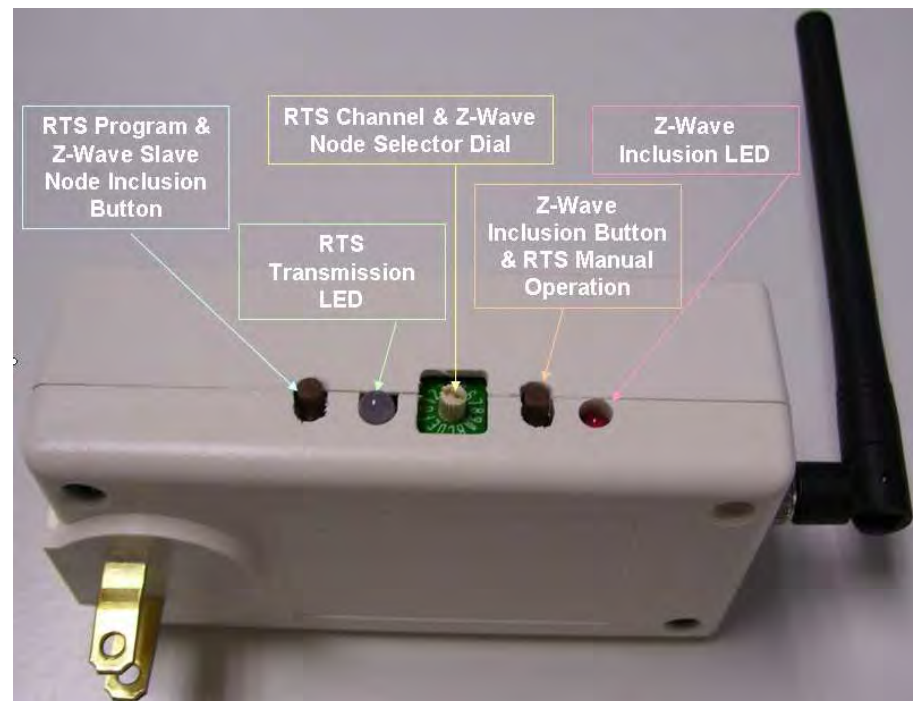

Z-Wave to Digital Motor Interface- ZDMI

Compatible with ILT and ST30 RS485 motors

One Per motor

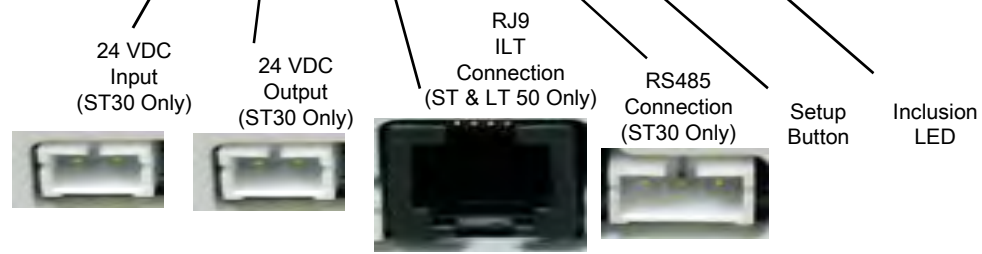

Z-Wave Card for Glydea

- One per motor
- Fits inside the Glydea motor

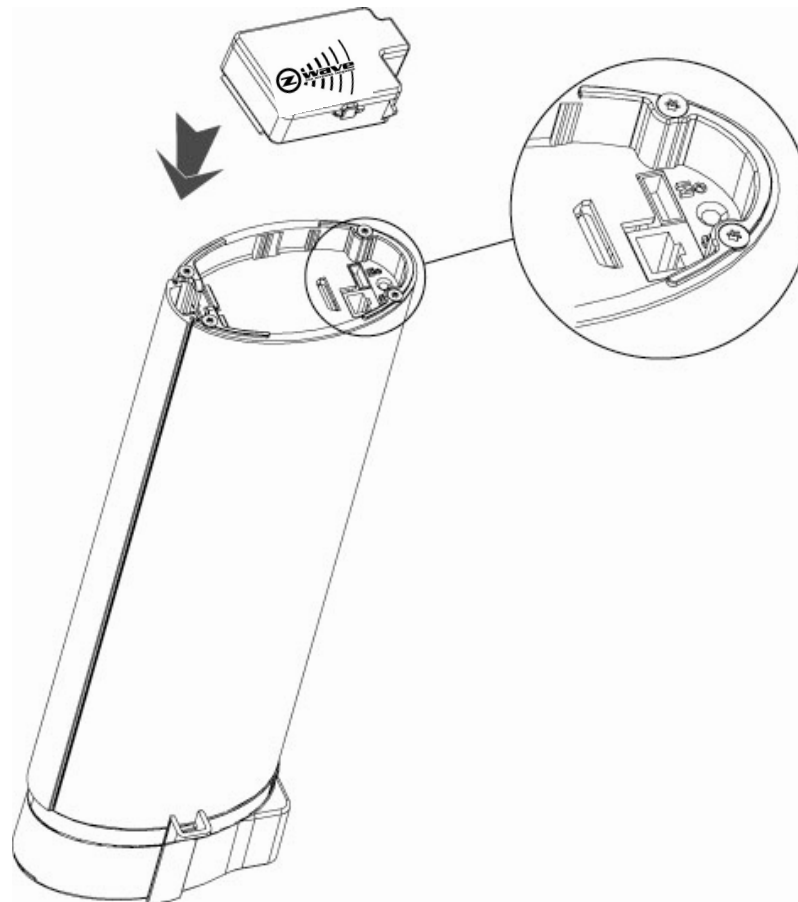

Z-Wave Light Switches

- All TaHomA lighting control solutions include a choice of Cooper, Leviton, and Evolve. All are factory optimized to install and perform through the TaHomA controller

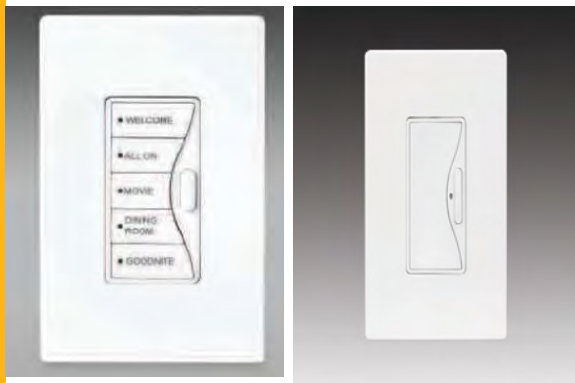

Cooper



Leviton



click to enlarge



click to enlarge

Evolve

Z-Wave Plug In modules

All TaHomA plug-in solutions include a choice of Cooper, Leviton, and Evolve. All are factory optimized to install and perform through the TaHomA controller



Leviton



Cooper



Evolve

Z-Wave Receptacle

- Fits into a standard junction box.
- On/Off Switching of table lamps, floor lamps, holiday lighting and fans.



Leviton



Cooper



Evolve

Z-Wave Thermostat



- A device to automatically turn on or off HVAC system.
- Digital Thermostats are more accurate than Mechanical to provide more energy saving
- 24V AC

Z-Wave Motion Sensor

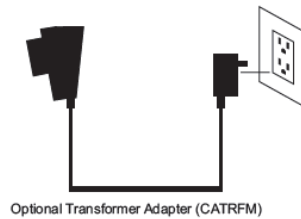
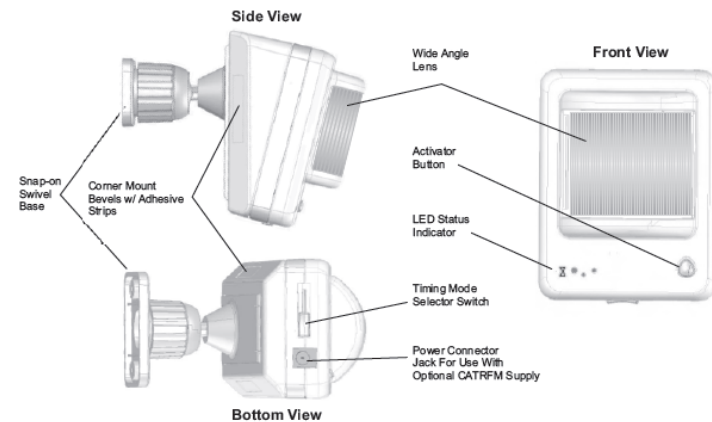

ON/OFF control

Wide detection Pattern can be used for whole room coverage

3- Mounting Options

Adjustable Timing features settings for pulse, 5 minutes, 10 minutes, 15 mts, and Manual Off time

FIRST FLOOR

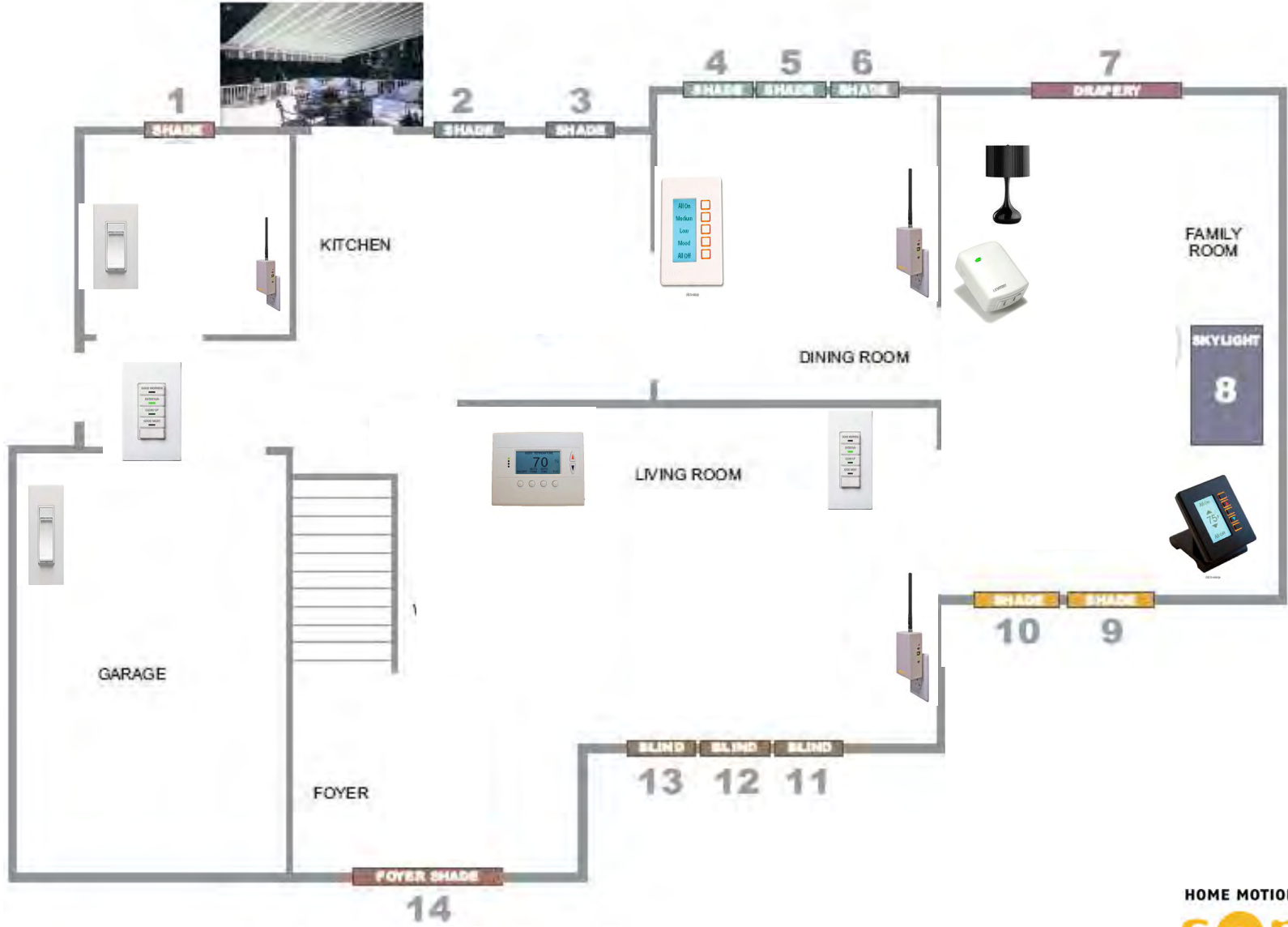

SECOND FLOOR

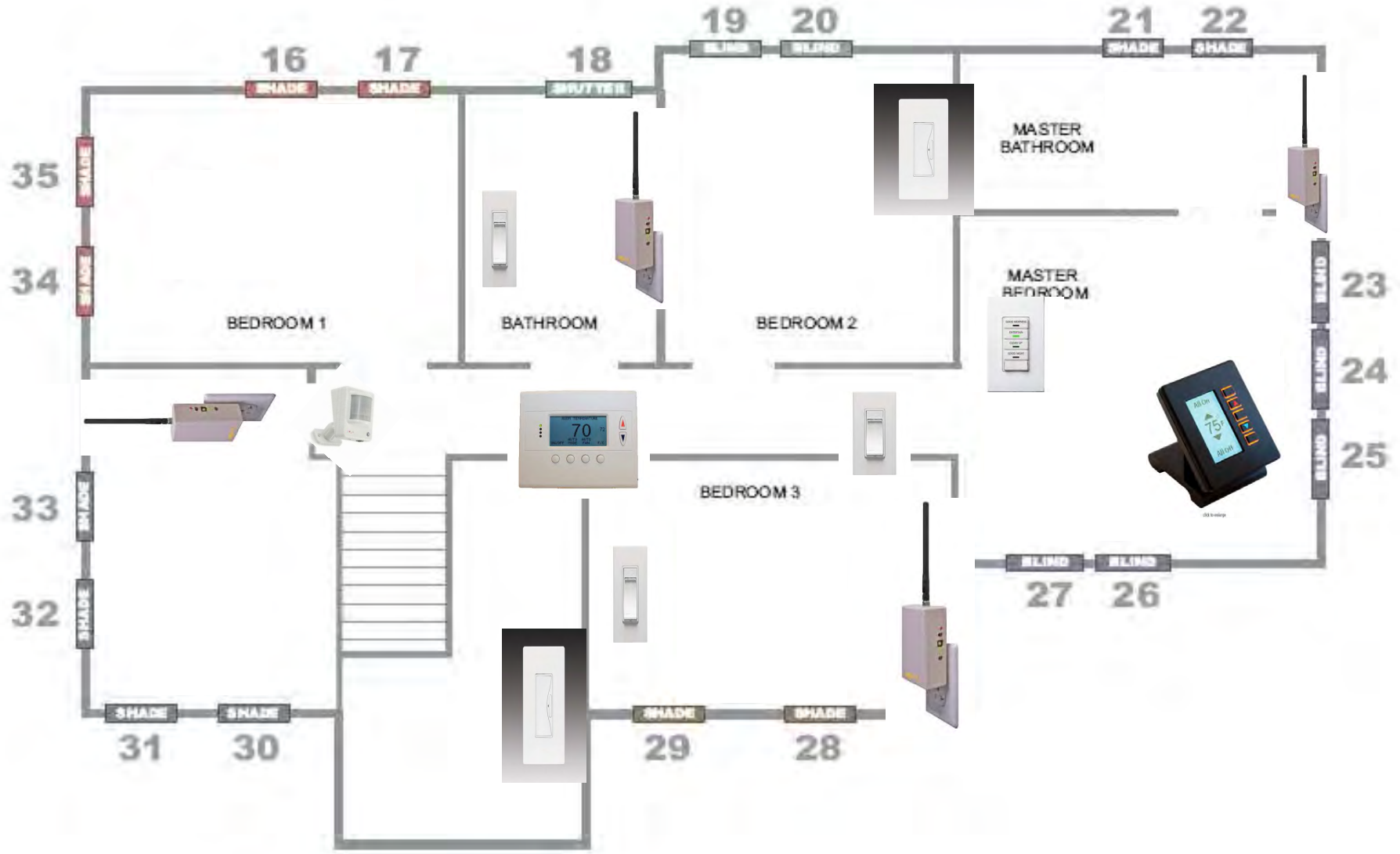

Intro To Programming

- **Dayton, NJ Showroom**

How To Sell TaHomA



Convenience-

- Enduser looking to control Shades through their iPad or iPhone App
- All on or All off Capabilities through Scene controllers
- To be able to walk into a room and have all lights go on and/or shades

my TaHomA

CONFIGURE SCENE SCHEDULES

go up

Thermostat once reaches certain temperature shades come down

Time Scheduling

- Automatically setting your home to come to life at different times
- Morning Mode-7am - Lights come on 25% in master bedroom and Kitchen goes up to 72 degrees, Window coverings go to the my position in Master bedroom and Kitchen

Energy Savings

- Providing a solution for management of Natural Gas and HVAC



LiveView Dashboard

Schedule Configuration

Marketing Collateral & Sales tool support Coming This Year

- **TaHoma brochure:**
- **Online Web site:**
 - <http://somfytahoma.com>
 - Online demo tool
- **Free demo app on Apple Store:**

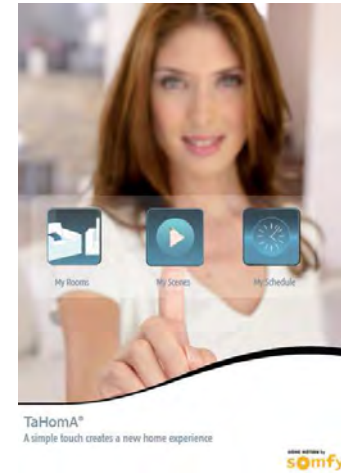
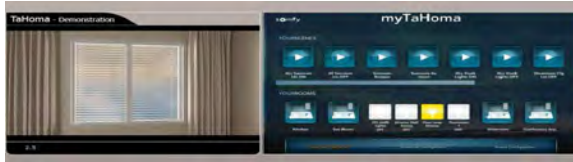

- **Demo case**
- **Tech support line 1-866-MYTAHOMA**
- **Training and Apps guide.**
- **Youtube video on ZRTSI programming**
- **Video showing TaHoma being used**



Authorized Dealer Training

- 1 day training to become an authorized dealer
- Pre-requisite-You must have gone through the Somfy Expert Training
- Cost-Travel and POS Display (training module) TBD
 - POS Display (training tool and showroom or in-home sample case)



TaHomA Advertising



CustomRetailer



A simple touch creates a new home experience.

A photograph of a woman with long brown hair, wearing a white top, pointing her right index finger towards a small icon of a house with a white roof and a window. The icon is set against a dark teal square background.

To learn more visit Somfy at CES booth #21266

HOME MOTION by **somfy.**



TaHomA – Trade Shows



2011 TaHomA Tradeshow Calendar

SHOW/EVENT	LOCATION	MARKET	DATES												
			JAN	FEB	MAR	APR	MAY	JUN	JUL	AUG	SEP	OCT	NOV	DEC	
EHX @ CES	Las Vegas, NV	HTI, IWC&D	6-9												
Budget Blinds Convention	Dallas, TX	IWC&D	23-26												
EHX Spring	Orlando, FL	HTI			17-19										
IWCE	Las Vegas, NV	IWC&D				26-28									
Kitchen & Bath Industry Show (KBIS)	Las Vegas, NV					26-28									
CEDIA	Indianapolis, IN	HTI									8-11				



Thank You!

www.somfytahoma.com

**A Simple Touch Creates A New
Home Experience!**